

# DIVERGE STOOL

by Skrivo

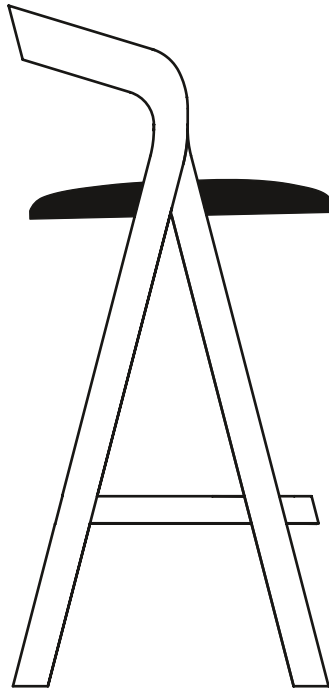

Diverge è la nostra proposta di sedia a compasso, dal tono contenuto e senza sbavature. Impara dall'architettura il rispetto per ogni dettaglio, trovando nella perfezione della struttura la propria identità. Diverge raggiunge così un linguaggio distinto e maturo che la porta ad essere applicata in contesti diversi, dal ristorante alla casa, definendo chiaramente il nostro studio nella sedia in legno.

Diverge is our idea for a compass chair, in a soft, flawless tone. It draws respect for each detail from architecture, finding its true identity in the perfection of the structure. Diverge thus attains a distinct, mature language that leads it to being applicable to various settings, from the restaurant to the home, clearly defining our studio in this wooden chair.

## DIMENSIONI | DIMENSIONS

lunghezza | width: 57,6 cm  
larghezza | depth: 47,7 cm  
altezza | height: 100,5 cm  
altezza del sedile | seat height: 74,6 cm

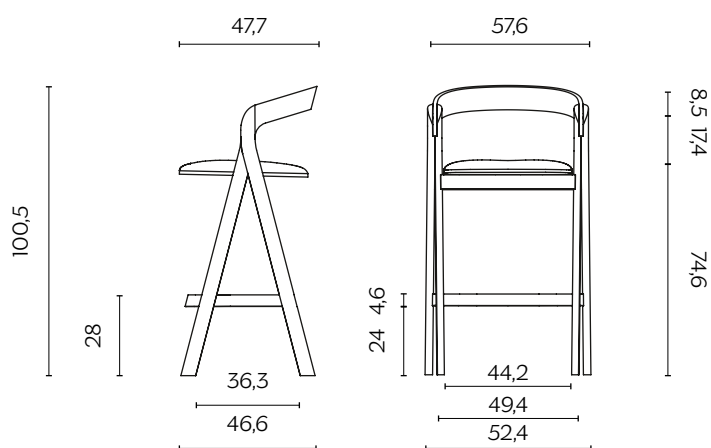

## FINITURE STRUTTURA | STRUCTURE FINISHES

### LEGNO | WOOD



Frassino  
Ash



Frassino Tinto Rovere  
Ash Stained Oak



Frassino Tinto Noce  
Ash Stained Walnut



Frassino Nero  
Black Ash

# TESSUTI | FABRICS

A

## LOOP

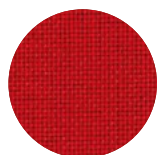

Rosso

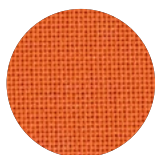

Arancione

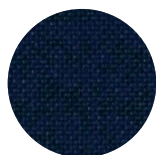

Blu notte



Cioccolato



Burro

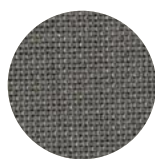

Grigio fumo



Nero

## TRAMÈ

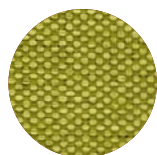

Mela

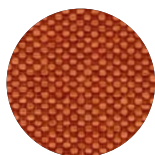

Arancio



Uva

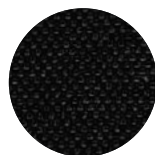

Nero



Beige

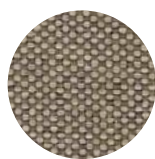

Tortora



Grigio scuro

# TESSUTI | FABRICS

A

## CANVA



Ciallo

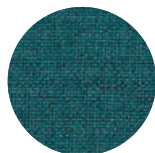

Petrolio

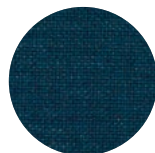

Blu



Sale



Sabbia

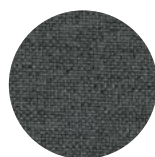

Grigio scuro

## PEPLO



Cannella



Rosso mattone



Giallo ocra



Grigio chiaro



Grigio tortora



Blu notte

## TESSUTI | FABRICS

B

### FLUKSO PLATINUM



Pesca

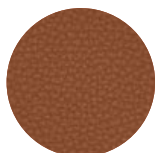

Mattone

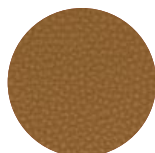

Nocciola



Verde



Porpora



Tortora



Nuvoloso

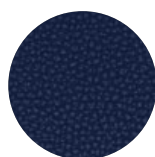

Blu

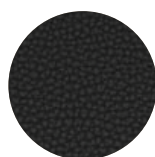

Nero

### FLUKSO REBEL ECONABUK



Nocciola



Seppia



Marrone



Grigio



Antracite

# TESSUTI | FABRICS

B

## VESCOM WILSON

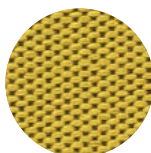

Ciallo elettrico

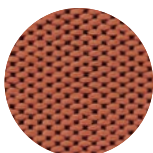

Rosé

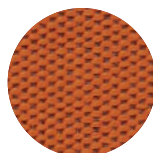

Energico

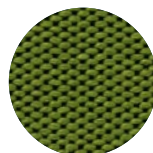

Laguna

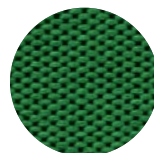

Prato

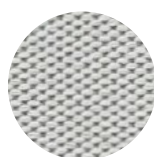

Neve

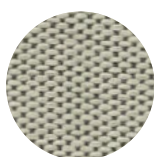

Sale e pepe

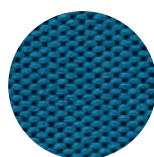

Zaffiro

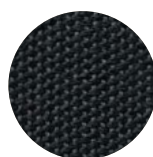

Crafite

## VESCOM NORFOLK

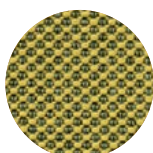

Ape



Rosa

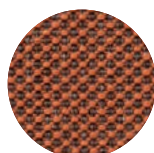

Mattone

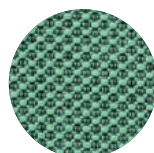

Latte e menta



Petrolio

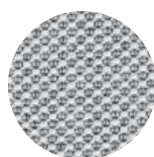

Chiaccio



Sale e pepe



Notte



Antracite

# TESSUTI | FABRICS

C

## KVADRAT RELATE

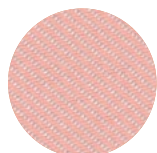

Rosa



Rosso

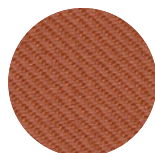

Terra



Snack



Menta

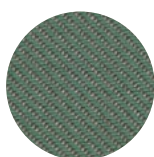

Verde bosco



Nuvolo

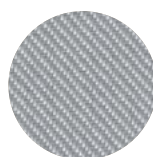

Grigio

## KVADRAT FIELD 2

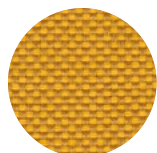

Zafferano

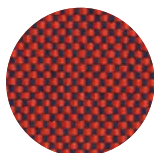

Ciliegia

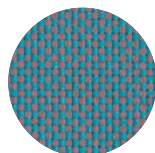

Zucchero

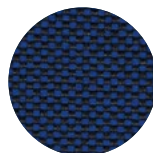

Blu

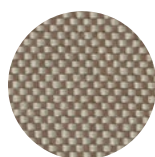

Nocciola

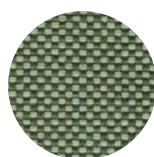

Menta

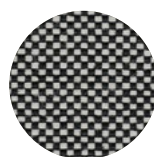

Sale e pepe

# TESSUTI | FABRICS

C

## VESCOM HARDING

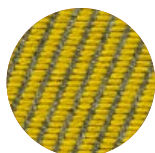

Ciallo

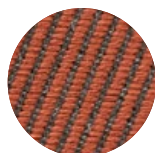

Rosso

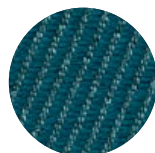

Petrolio



Nuvolo



Crigio chiaro

## VESCOM ROLLA

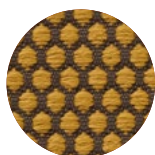

Mostarda

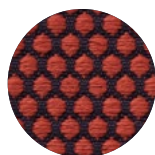

Ciliegia



Blu pavone



Latte

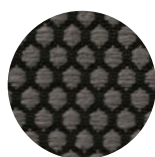

Crafite



Blu notte



## TESSUTI | FABRICS

C

### VESCOM MOORE



Margherita

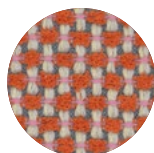

Lampone

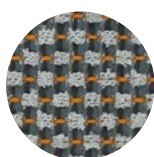

Saetta

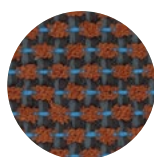

Uva

### TORRILANA GUBBIO

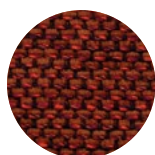

Ambra

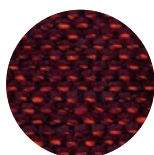

Bordeaux

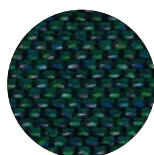

Verde Petrolio

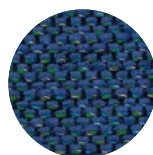

Blu elettrico

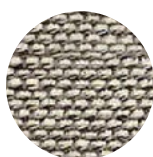

Sale e pepe



Castagna

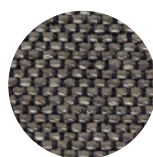

Tortora

# TESSUTI | FABRICS

C

## BIG BOSS



Nuvola

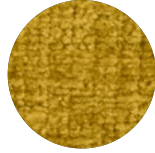

Senape



Nocciola

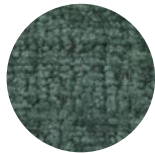

Turchese

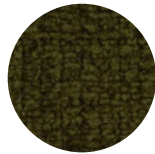

Muschio



Porpora

## MAHARAM METRIC

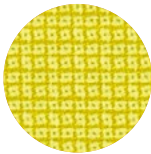

Canary

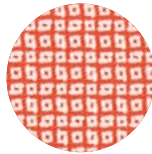

Cala



Lava

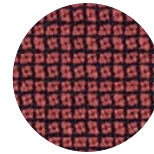

Kiln

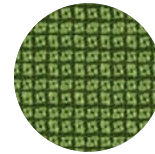

Alligator



Middy



Talisman

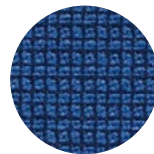

Seaport

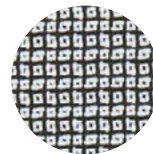

Film

# TESSUTI | FABRICS

D

## MAHARAM MERIT



Salmone

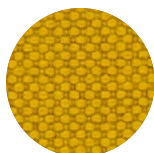

Ciallo

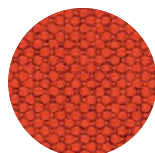

Rosso corallo

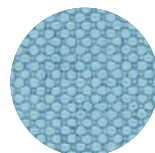

Celeste



Marrone

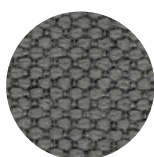

Crigio



Sale e pepe

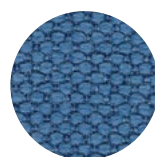

Blu cobalto

## ROHI SERA

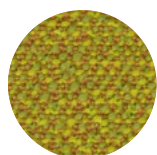

Tivoli

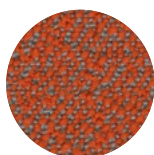

Glow

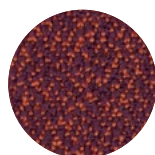

Berry

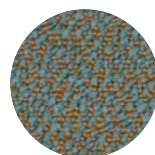

Mirage



Pepper

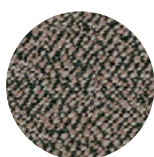

Walnut



Rosewood

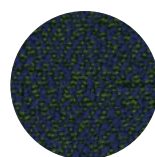

Mare

# TESSUTI | FABRICS

D

## ROHI MICA



Sanddorn

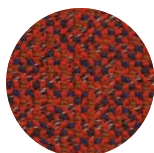

Indio

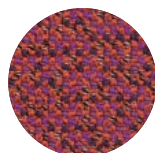

Brevia

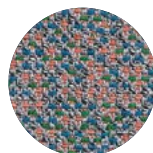

Papillon

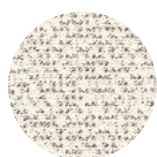

Calla



Crisp

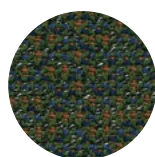

Jungle

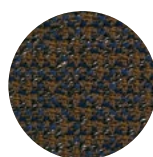

Secret

## ROHI CLEO



Lemon

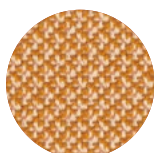

Peach

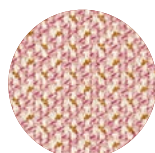

Flamingo

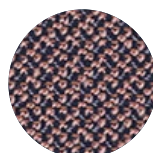

Azalee

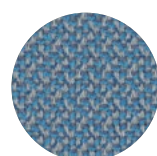

Sky



Ocean

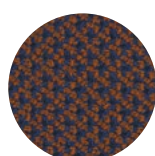

Magma



Pepper

## TESSUTI | FABRICS

D

### ERIMITI CLOUD



Panna



Noce



Nocciola



Bordeaux

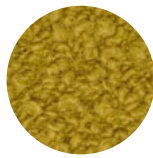

Senape

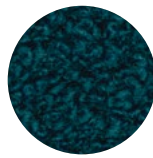

Petrolio

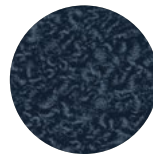

Blu notte

### TORRILANA BRIONNE

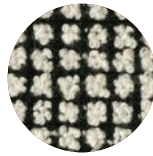

Black and white

## TESSUTI | FABRICS

E

### KVADRAT STEEL CUT TRIO 3

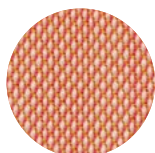

Pesca

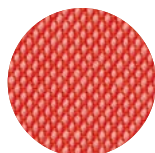

Arancia rossa

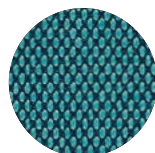

Pavone



Sale e pepe

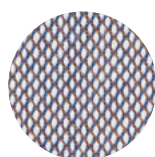

Elettricità

### VELLUTO

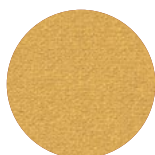

Soleggiato



Teddy



Cannella



Tobacco



Ostrica



Jeans



Notturmo

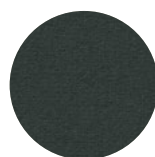

Balsamico

## TESSUTI | FABRICS

E

### DEDAR VOULEZ-VOUS

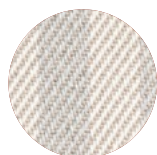

Sambuco



Cirasole

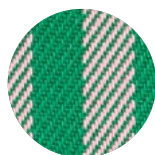

Fragola e menta



Tiramisu



Amarena



Tabacco



Noce di cocco

# TESSUTI | FABRICS

F

## KVADRAT SUUNTA

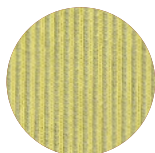

Primavera



Narcis

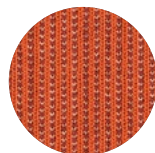

Tulip

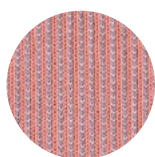

Peony

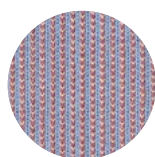

Crocus

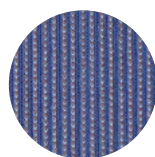

Iris

## KVADRAT TERO OUT

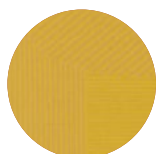

Sole



Verde prato



Borgogna

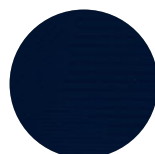

Notte



Panna



Nuvole

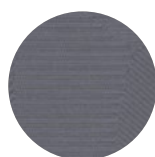

Robot



Tabacco



# TESSUTI | FABRICS

F

## MAHARAM OXBOW

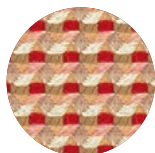

Dianthus

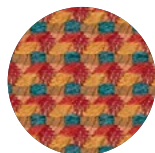

Montage

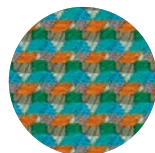

Nouveau

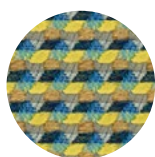

Legume

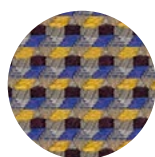

Module

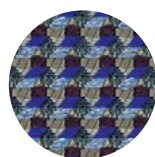

Trope

## SAHCO ZERO

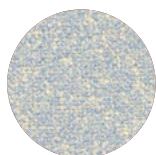

Zucchero



Candido

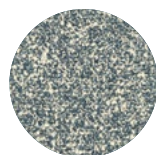

Petrolio

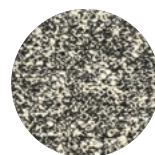

Sale e pepe

## TESSUTI | FABRICS

C

### DEDAR TIGER BEAT

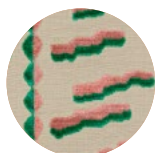

Fragola menta

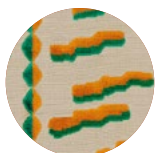

Papaya



Fauve



Tabacco



Fumo

### DEDAR AMULETO



Corallo



Rubino



Smeraldo



Alabastro



Occhio di tigre